

※ 尺寸/Dimensions 单位/Unit: (mm)

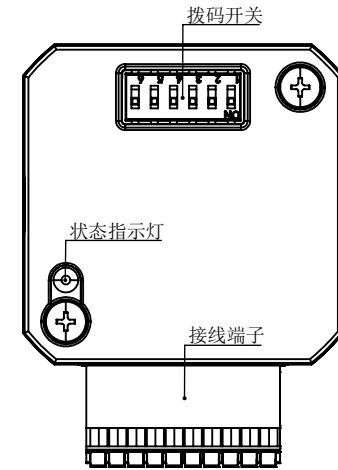

※ 规格/ Specification	
输入电压范围	8-48vdc
输出力矩范围	最大0.4N.m
电流设置	软件可调, 0.5~6.5可调, 出厂适配电机
细分设置	软件200-1000000整数可调, 出厂默认4000
编码器反馈	1000线(4000 Counts)编码器反馈
非易失性存储	配置参数存储在MCU内部的FLASH中
重量	≈0.3 Kg
转子惯量	≈ 54 g.cm <sup>2</sup>
通讯方式	Modbus-RS485
波特率	115200
数据位	8
停止位	1
校验位	无

※ 端口功能/Port Function		
序号	名称	功能
1	V+	电源正 (8-48vdc)
2	V-	电源地 (GND)
3	X0+	光电隔离, 差分, 兼容5~24VDC, 可作为通用输入或高速脉冲输入, 滤波频率300KHz, 可通过上位机定义端口功能, 滤波频率。
4	X0-	
5	X1+	光电隔离, 差分, 兼容5~24VDC, 可作为通用输入或高速脉冲输入, 滤波频率300KHz, 可通过上位机定义端口功能, 滤波频率。
6	X1-	
7	485A	通讯端口, 通过主站MODBUS指令可对从站驱动器进行控制, 注意主站波特率必须与从站一致, 出厂默认波特率为115200, 数据位8, 停止位1, 无校验。
8	485B	
9	Y0+	报警状态输出端口, 可检测电机报警状态, 默认常闭, 正常时输出。 可通过软件
10	Y0-	取反或设置成其他功能。

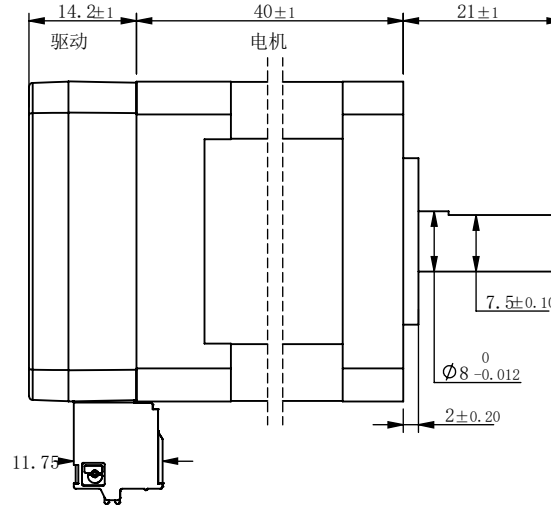
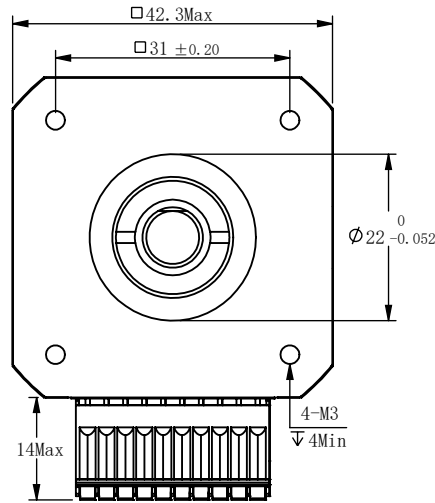
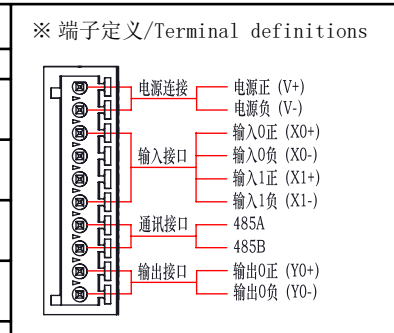

※ 铭牌内容/Label description	
型号/Model	IH42ET04
品号/Product No.	

※ 拨码设置/Serial port Settings																																
地址	1	2	3	4	5	6	7	8	9	10	11	12	13	14	15	16	17	18	19	20	21	22	23	24	25	26	27	28	29	30	31	32
SW1	ON	OFF	ON	OFF	ON	OFF	ON	OFF	ON	OFF	ON	OFF	ON	OFF	ON	OFF	ON	OFF	ON	OFF	ON	OFF	ON	OFF	ON	OFF	ON	OFF	ON	OFF	ON	OFF
SW2	ON	ON	OFF	OFF	ON	ON	OFF	OFF	ON	ON	OFF	OFF	ON	ON	OFF	OFF	ON	ON	OFF	OFF	ON	ON	OFF	OFF	ON	ON	OFF	OFF	ON	ON	OFF	OFF
SW3	ON	ON	ON	ON	OFF	OFF	OFF	OFF	ON	ON	ON	ON	OFF	OFF	OFF	OFF	ON	ON	ON	ON	OFF	OFF	OFF	OFF	ON	ON	ON	ON	OFF	OFF	OFF	OFF
SW4	ON	ON	ON	ON	ON	ON	ON	ON	OFF	OFF	OFF	OFF	OFF	OFF	OFF	OFF	ON	ON	ON	ON	ON	ON	ON	ON	ON	ON	ON	ON	ON	ON	ON	ON
SW5	ON	ON	ON	ON	ON	ON	ON	ON	ON	ON	ON	ON	ON	ON	ON	ON	OFF	OFF	OFF	OFF	OFF	OFF	OFF	OFF	OFF	OFF	OFF	OFF	OFF	OFF	OFF	OFF

第一角画法 Frist Angel View			名称/Name	
公差 Tolerance	比例 Scale	页码 Sheet	集成式步进伺服 Integrated step servo	
±0.3	1:1	1/1		

备注: 需要其他地址可通过上位机设置基地址, 默认基地址为1。实际地址=拨码地址+基地址-1 SW6: 用于设定终端电阻, OFF时为0欧姆, ON时为120欧姆

